

An example of complexity in magnetism: Complex magnetic structures in Rare-Earth intermetallics

J C Gómez Sal ¹, J I Espeso Martínez ¹, J Rodríguez Fernández ¹, N Marcano Aguado ^{1,2},
A Señas ¹, J García Soldevilla ¹ and J Blanco ³

1. Department CITIMAC-University of Cantabria, Spain.

2. Instituto de Nanotecnología de Aragón. INA.- University of Zaragoza, Spain

3. Departamento de Física . Universidad de Oviedo. Spain

E-mail : gomezjc@unican.es

(Received 15 February 2008)

Abstract

We present and compare the magnetic structures of limit compounds, between the ferromagnetism and antiferromagnetism in the pseudobinary compounds of type RNi/Pt/Cu, where R = Tb, Gd, Nd or Ce, appearing when we substitute the transition metal. All of them are examples of complex magnetic structures as the result of different magnetic interactions, inhomogeneities and disorder. This overview provides us a fruitful field of discussion considering the competition of magnetic interactions in a context of disorder. We discuss the similarities and differences between the structures and we conclude about the importance of the disorder in the existence of several phenomena in magnetism, which could lead to new insights in the stability of magnetic phases, as clusters glass or short range interactions in the mesoscopic scale.

Keywords: magnetic structures, neutron diffraction, magnetic interactions.

1. Introduction

In spite of an initial easy comprehension of the magnetic phenomena, most of them need a more intense and deep study to really be well understood, as is the case for Rare-Earth-based compounds [1]. The first simple antiferromagnetic structures as (MnO) [2], obtained in the first days of neutron diffraction, only appears in a few compounds and a large number of other magnetic arrangements, such as non collinear ferromagnetic, incommensurate (with equal or no equal magnetic moments), multi-q and multi-phase structures, have been discovered [3,4]. In addition, the new programs and computing facilities, together with a higher resolution of the diffractometers, allow discriminating important details that in the first studies were not attainable [5].

From another point of view, it is really difficult to find a unique origin for the magnetic behaviours. In fact, they are usually consequence of the magnetic competition of several interactions, steric and electronic effects and, in many cases, in the presence of disorder. The causes of disorder may range from the existence of particular magnetic impurities to a net phase segregation, going through mesoscopic inhomogeneities, clustering

effects or disorder in the magnetic interactions [6]. All these facts convert magnetism in a continuous source of frontier physics, not only from the point of view of understanding, but also for the discovery of new materials, such as those with giant or colossal magnetoresistance, coexistence of magnetic order and superconductivity, magnetocaloric or form memory, non Fermi liquids and quantum phase transitions, strongly correlated electron systems, etc. [7,8]

In intermetallic Rare-Earth transition metal systems, a large variety of those behaviours were found [9]. From many years ago, a great effort has been developed in many laboratories and, in particular, in our group of magnetism at the University of Cantabria [10], in order to get a good understanding of the different phenomena appearing in those compounds.

We have paid special attention to the pseudobinary 1:1 compounds [11-15], according to the scheme presented in figure 1. In all the compounds presented here only the Rare-Earth ions carries magnetic moment. The substitutions take only place in the transition metal site. When Ni is substituted by Pt, only the cell volume is changed and the ferromagnetic character remains, while

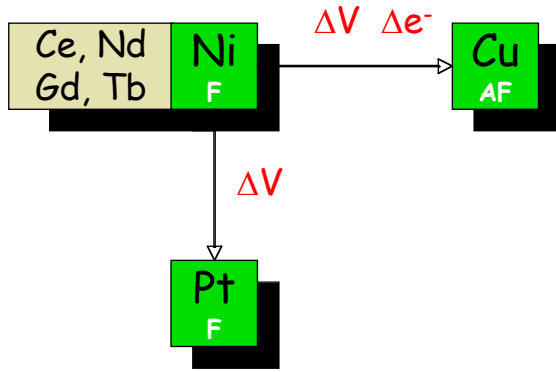

Figure 1. Scheme of substitution in equiatomic R M compounds.

the substitutions of Ni or Pt by Cu involve a change from ferro to antiferromagnetism. The studies have been systematically carried out for Nd, Gd, Tb and Ce. The most important issues obtained from those studies were:

- The obtained structures are the consequence of a competition of positive and negative interactions and a strong magnetocrystalline anisotropy, which determines the magnetic moment direction. In the case of Gd, a helimagnetic structure is allowed with magnetic moments moving in the xz plane.
- The complete study shows that the electronic effects are determinant to impose the change from ferro to antiferromagnetism along the series. In the case of $\text{GdPt}_{1-x}\text{Cu}_x$ or $\text{TbPt}_{1-x}\text{Cu}_x$, where the cell volume is unchanged, we observe a similar magnetic behaviour (with changes from ferro to antiferromagnetism) as in the corresponding $\text{RNi}_{1-x}\text{Cu}_x$ series, where a 4% change in volume is observed.
- These results are in agreement with the simple model proposed by A. Hernando et al. [16], which implies that the ferromagnetism is related to a high density of states at the Fermi level, $n(E_F)$, whilst the antiferromagnetism appears for lower $n(E_F)$ values.
- In the case of $\text{CePt}_{1-x}\text{Ni}_x$, the system was the first experimental example of the Doniach diagram, which models the competition between the RKKY and Kondo interactions [17].
- In $\text{CeNi}_{1-x}\text{Cu}_x$, a cluster-glass state was found above the ferromagnetic long-range one, which appears by means of a percolative process [15,18,19].

The maximum complexity of the magnetic structures occurs in the limit between ferro and antiferromagnetic behaviours. We try to compare and analyze in this paper the observed structures for those limit compounds, in order to understand the diverse degrees of complexity exhibited. We have chosen several series: heavy (Tb) or light (Nd) Rare-Earths, ($L=0$) and without crystal field effects (no magnetocrystalline anisotropy) (Gd) and the particular case of Ce, which is a strongly correlated electron system.

The selected compounds and the characteristics of the obtained magnetic structures are summarized in table 1. After a particular description of each case, we will finish with a general discussion and comments about the

Table 1. The characteristics of selected magnetic structures.

$\text{NdNi}_{1-x}\text{Cu}_x$		
Ferro $0.4 \leq x \leq 0.8$	Noncollinear ferromagnetic (NCF) (F_x-C_z)	$T_C \approx 37\text{K}$
$\text{NdNi}_{0.2}\text{Cu}_{0.8}$	Noncollinear ferromagnetic (NCF) (F_x-C_z)	$27\text{K} > T > 18\text{K}$
	NCF + Incommensurate $ q = 0.28\text{\AA}^{-1}$	$T < 18\text{K}$
Antiferro $0.8 < x < 1$	2 propagation vectors: Helimagnetic	
$\text{TbPt}_{1-x}\text{Cu}_x$		
Ferro $0 \leq x < 0.3$	Noncollinear ferromagnetic (NCF) ($-C_xF_z$)	$56\text{K} > T > 48\text{K}$
$\text{TbPt}_{0.3}\text{Cu}_{0.7}$	Amplitude modulated $q=(0,0.17,0)$ ($C_xG_yF_z$)	$39\text{K} > T > 21\text{K}$
	Noncollinear ferromagnetic (NCF) ($-C_xF_z$)	$T < 30\text{K}$
Antiferro $0.4 < x \leq 0.7$	2 propagation vectors	$T < 37\text{K}$
$\text{TbNi}_{1-x}\text{Cu}_x$		
$\text{TbNi}_{0.7}\text{Cu}_{0.3}$	Noncollinear ferromagnetic (NCF) (F_xC_z)	$T_C = 38\text{K}$
$\text{TbNi}_{0.6}\text{Cu}_{0.4}$	Amplitude modulated $q=(0,0.15,0)$	
$\text{GdNi}_{1-x}\text{Cu}_x$		
$\text{GdNi}_{0.7}\text{Cu}_{0.3}$	Collinear ferromagnetic (F_y)	$T_C = 68\text{K}$
$\text{GdNi}_{0.6}\text{Cu}_{0.4}$	Helimagnetic $q=(0,0,0.25)$ (moments in ab plane)	$T_N = 63\text{K}$
$\text{CeNi}_{1-x}\text{Cu}_x$		
Ferro $0.2 < x \leq 0.7$	Collinear ferromagnetic (F_y) + Cluster-glass	
$\text{CeNi}_{0.2}\text{Cu}_{0.8}$	NCF + Conical $ q =0.3\text{\AA}^{-1}$	
Antiferro $0 < x \leq 0.1$		

physics involved in these selected structures and the disorder and complexity consequences.

2. Selected limit compounds with complex magnetic structures

Only the Rare-Earth carries localized magnetic moment in all the studied compounds. The magnetic interactions leading to long-range magnetic order are RKKY-type, which are described by an oscillating function with a period depending on $k_F \cdot \vec{r}_{ij}$, being \vec{r}_{ij} the distance between the Rare-Earth atoms and k_F the Fermi level of the conduction band. The crystalline electric field, being important for Rare-Earths lying in a low symmetry site, as is the case in FeB structures, imposes an easy magnetization direction related to the symmetry planes or axes. The Ni/Pt/Cu substitutions induce, on the one hand, an increase in the cell volume, but also in the number of conduction electrons, then resulting in a modification of the Fermi surface. In addition to these general features, each one of the selected series has its

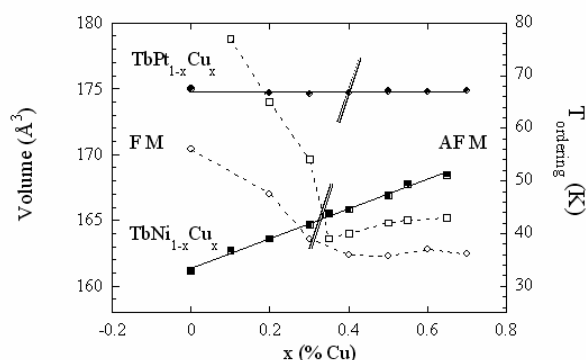

Figure 2. Cell volume at 300 K and ordering temperatures of the compounds TbPt_{1-x}Cu_x and TbNi_{1-x}Cu_x. Vertical marks indicate the region for which the change FM-AFM occurs.

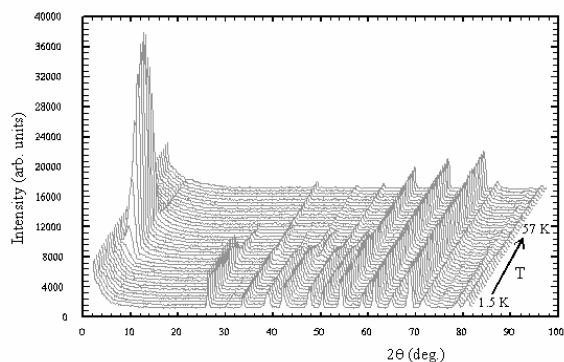

Figure 3. Thermodiffractogram of the compound TbPt_{0.7}Cu_{0.3} for temperatures between 1.5 and 60 K.

own characteristics that we will describe below.

2. 1. TbPt_{1-x}Cu_x: TbPt_{0.7}Cu_{0.3} structure [11]

The comparison of the TbPt_{1-x}Cu_x and the TbNi_{1-x}Cu_x series was definitive to understand the changes from ferro to antiferromagnetism in these compounds. As can be seen in figure 2. The magnetic behaviour of both series is independent of the change in cell volume. We deduced then, that the electronic effects (changes in the number of conduction electrons that modify the shape and value of the Fermi surface) are mostly responsible for the magnetic behaviour of the series.

The neutron diffraction experiments were performed in this series and we crushed the samples into fine powder and, in order to release the stress, the powder was sealed into an evacuated quartz ampoule and subsequently annealed at 750°C for two days. The ferromagnetic compositions from TbPt to $x < 0.3$ are noncollinear ferromagnetic $-C_xF_z$, according to the Bertaut notation (20), with the magnetic moments lying in the same plane as the Nd-based compounds but being the ferromagnetic direction onto the c axis. The TbPt_{0.7}Cu_{0.3} presents the change from ferro to antiferromagnetism. The antiferromagnetic structure established at 37K evolves towards ferromagnetic at 23K. Figure 3 shows the thermodiffractogram between 1.5 and 60K, and figure 4 the domain range of the two characteristic peaks: (0,0,1) for the ferromagnetic structure and (0,0,0)[±] for the

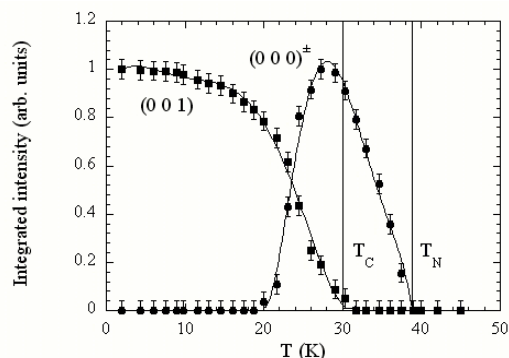

Figure 4. Thermal dependence of the (0 0 0)[±] and (0 0 1) reflections corresponding to the incommensurate and ferromagnetic noncollinear $-C_xF_z$ structures, respectively, of the compound TbPt_{0.7}Cu_{0.3}. The vertical lines correspond to the ordering temperatures of each magnetic phase.

incommensurate one. As we can see, between 21 and 30K both structures coexist. The ferromagnetic structure is of $-C_xF_z$ -type, similar to the compounds with lower Cu content, whilst the incommensurate one is indexed with a (0,0.17,0) propagation vector, and corresponds to a longitudinal sinusoidally modulated one along the y axis, with three component magnetic moment arranged as (C_x, G_y, F_z) .

The pure antiferromagnetic compounds ($0.4 \leq x \leq 0.7$) present similar incommensurate structures, although in some cases we have only been able to determine the modulus of the propagation vector.

It is interesting to point out that the corresponding TbNi_{0.7}Cu_{0.3} is ferromagnetic with a noncollinear F_xC_z structure, with the ferromagnetic component along the x axis, as in the case of the NdNi_{1-x}Cu_x series. The TbNi_{0.6}Cu_{0.4} is yet antiferromagnetic with a sinusoidal structure and a propagation vector along the y direction, in agreement with the first neutron studies carried out in Grenoble [21]. However, for this last series we have no data about the compound corresponding to the change from ferro to antiferromagnetism.

2. 2. GdNi_{1-x}Cu_x: GdNi_{0.4}Cu_{0.6} structure [12]

Neutron diffraction studies in Gd-based compounds are not very common due to the high absorption cross section at high λ values. The D4 diffractometer at the ILL is one of the few instruments in the world that allows performing this kind of measurements. It is placed at a hot beam line and uses a $\lambda = 0.5 \text{ \AA}$, with a much smaller absorption cross section.

In this case we have not data about the critical composition in the limit of ferro to antiferromagnetism, which is around $x=0.5$. However, it is especially interesting due to the absence of magnetocrystalline anisotropy ($L=0$). Two are the main results from these structures:

a.- For the ferromagnetic compounds, the magnetic structure is collinear ferromagnetic, with the magnetic moments in the b direction (F_y), for both crystalline structures: CrB (GdNi) and FeB (GdNi_{0.7}Cu_{0.3}). For the

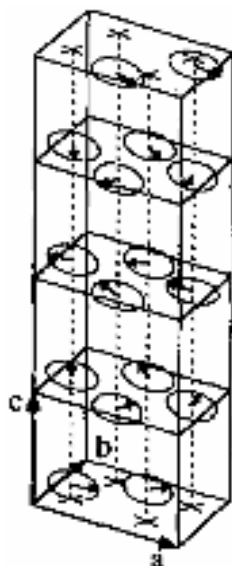

Figure 5. The helimagnetic structure of $\text{GdNi}_{0.4}\text{Cu}_{0.6}$.

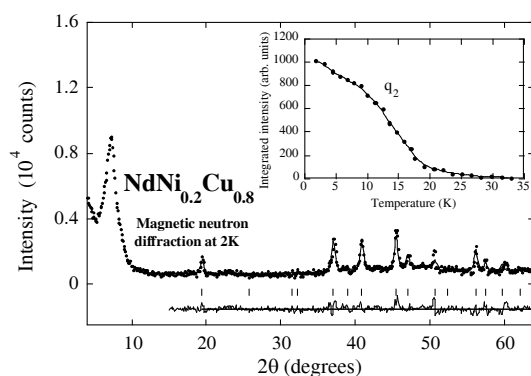

Figure 6. Magnetic contribution at 2 K to the neutron diffraction pattern for $\text{NdNi}_{0.2}\text{Cu}_{0.8}$. It has been obtained by subtracting the paramagnetic pattern at 40 K. The inset shows the temperature dependence of the magnetic intensity of the low angle magnetic peak observed around $2\theta = 7^\circ$ associated with q_2 .

antiferromagnetic ones, the structure presented in figure 5 is helimagnetic, with the moments in the ab plane and the propagation vector $(0,0,0.25)$ in the c direction. Further studies on specific heat [22] concluded that the spins fluctuations near the critical temperature play an important role in the stability of the structures and lead to the existence of short-range correlations at temperatures higher than T_C or T_N . However, there is not a particular study for the limit compound.

2. 3. $\text{NdNi}_{1-x}\text{Cu}_x$: $\text{NdNi}_{0.2}\text{Cu}_{0.8}$ structure [13]

All the studied compounds were polycrystals. The melting process is not eutectic and we studied the best preparation conditions in order to obtain homogeneous samples, at least, at the micrometric scale, as can be detected by X-ray diffraction, neutrons and scanning electron microscopy.

The stability range of the FeB (Pnma) orthorhombic structure goes from $x=0.4$ to $x=1$, and the change from

ferro to antiferromagnetism takes place around $x=0.8$.

The magnetic structures have been obtained by neutron diffraction at the D1B diffractometer of the Institute Laue-Langevin at Grenoble, France. For compounds with $0.4 \leq x < 0.8$, a noncollinear ferromagnetic structure (F_x-C_z in Bertaut's notation) is found below T_C around 37K. The magnetic moments lie in the ac plane, being a the ferromagnetic direction.

For the limit compound $x=0.8$, the same F_x-C_z arrangement was found in the temperature range $27\text{K} > T > 18\text{K}$. However, below 18K, in addition to the previous structure, a low angle peak develops. It can be indexed with an incommensurate propagation vector $q=0.28\text{\AA}^{-1}$ (see figure 6). The width of this peak is large, reflecting a lack of homogeneity in this incommensurate arrangement, with important short-range spin correlations. A Rietveld refinement is not possible due to the absence of intensity in other peaks associated to this q vector.

For this compound it seems that the ferromagnetic structure becomes distorted by antiferromagnetic short-range correlations at low temperatures, which are the precursor of the pure AF structures, obtained for the $x=0.9$ sample and NdCu. The magnetic structures of these non commensurable compounds present two propagation vectors and where defined as helimagnetic. (See table 1)

2. 4. $\text{CeNi}_{1-x}\text{Cu}_x$: $\text{CeNi}_{0.2}\text{Cu}_{0.8}$ structure [14]

This series was especially interesting due to the existence of a Kondo interaction in addition to RKKY and crystal electric field effects. The FeB orthorhombic structure remains stable from CeCu to $x=0.15$ and the change from antiferro to ferromagnetism occurs around $x=0.8$. The value of the magnetic moments is smaller than that of the other series mentioned above and a progressive decrease of this value is observed once the Kondo interaction becomes more important, with the increasing amount of Ni.

The scheme of the magnetic structures obtained for the antiferromagnetic compounds (CeCu and $\text{CeNi}_{0.1}\text{Cu}_{0.9}$) and for one of the ferromagnetic ones are presented in figure 7. CeCu presents a $(1/2,0,0)$ antiferromagnetic structure, while, for the $x=0.9$ compound, the magnetic diffraction pattern presents two coexisting propagation vectors, $q_1=(1/2,0,0)$ and $q_2=(0,1/2,0)$, but from these experiments we cannot distinguish between the existence of separated magnetic phases or a double- q magnetic structure.

The structure of the ferromagnetic compounds ($0.3 \leq x < 0.8$) is a collinear F_y one, with the magnetic moments progressively reduced by the increasing Kondo effect (see figure 8). However, the magnetic neutron spectra for the $\text{CeNi}_{0.2}\text{Cu}_{0.8}$ sample, which is in the limit between ferro and antiferromagnetism, is much more complicated (see figure 9). Two propagation vectors have been detected. One is $q_1=0$, corresponding to the ferromagnetic structure, but in this case a noncollinear one, because the $(0,0,1)$ reflection is forbidden by the selection rules of the FeB nuclear structure. The other is a

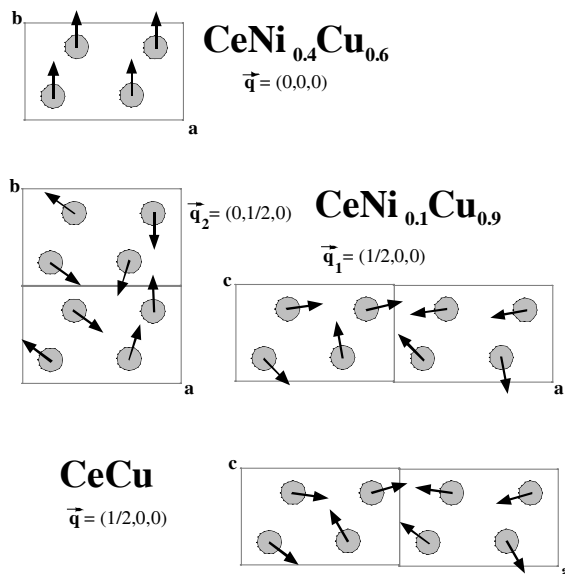

Figure 7. Sketch of the evolution of the magnetic moment arrangement in $\text{CeNi}_{1-x}\text{Cu}_x$ within the ordered state ($x = 0.6, 0.9$ and 1.0) as determined by neutron diffraction. Ni/Cu ions are omitted for clarity.

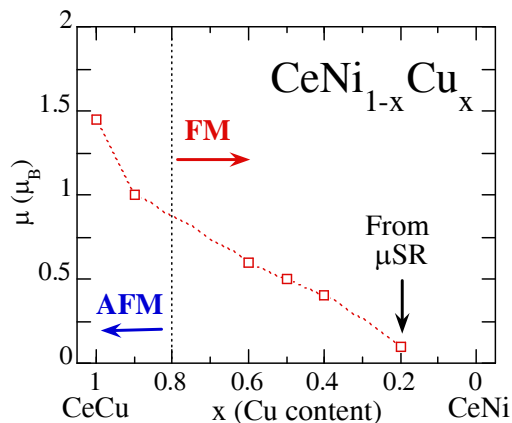

Figure 8. Magnetic moment of the Ce ion as a function of Cu content in the $\text{CeNi}_{1-x}\text{Cu}_x$ series. The ordered moment for $x = 0.2$ has been estimated from μSR data. The line is used as a visual guide.

low angle peak corresponding to an incommensurate propagation vector $q_2 = 0.30\text{\AA}^{-1}$. This peak has a large width, indicating the existence of magnetic inhomogeneities. Considering both propagation vectors, a magnetic structure with a conical character is described.

In this case, it is clear the complex evolution of the magnetic structures in this series. One of the most important facts in this series is the existence of a cluster-glass phase above the ferromagnetic domain for the compounds with $x \leq 0.7$. This fact, appearing uniquely in the Ce compounds, is produced by the existence of short-range correlations leading to a cluster-glass state, which percolates at low temperatures into a long-range ferromagnetic order. This phenomenology has been widely explained in different articles [15,18,19] and is a good example of the so called Griffiths phase description [23].

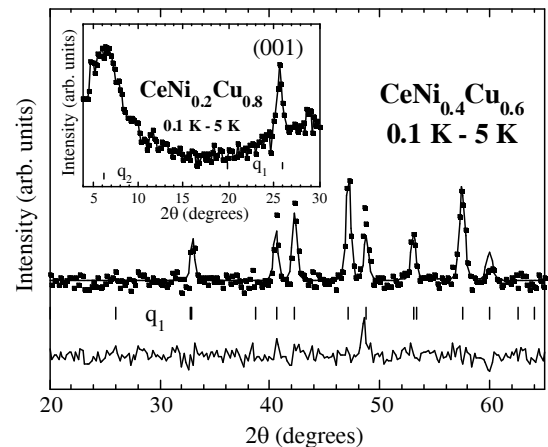

Figure 9. Magnetic contribution to the neutron diffraction pattern for $\text{CeNi}_{0.4}\text{Cu}_{0.6}$ and $\text{CeNi}_{0.2}\text{Cu}_{0.8}$ compounds. Points indicate the experimental data and lines are the calculated and difference patterns. Vertical ticks mark the magnetic reflections: $|q_1| = 0$ and $|q_2| = 0.3\text{\AA}^{-1}$.

3. Discussion

Considering the previous data, the first comment is about the stability domain of the antiferromagnetic behaviour along the series. While for Ce and Nd the antiferromagnetism is only stable very close to the Cu limit ($0 \leq x \leq .2$), for the Tb case, the antiferromagnetism still holds at $x=0.7$. This could be a consequence of the Lanthanide's contraction. The 3+ ionic radius of the heavy Rare-Earths, as Tb or Gd, is smaller than that of light Rare-Earths, as Ce or Nd. The cell volume of the compounds decreases as the Rare-Earth atomic number increases. A simple but illustrative explanation for this fact could be given: as far as the cell volume becomes smaller, the hybridization of the corresponding wave functions increases, leading to a larger band and a smaller density of states at the Fermi level. Following the conclusions of the model proposed by A. Hernando et al. [16], small values of $n(E_F)$ favour the antiferromagnetism, according to our experimental results.

In all the border compounds presented here, it has been found the existence of at least two magnetic propagation vectors, corresponding to the ferro and antiferromagnetic structures. However, only in $\text{TbPt}_{0.7}\text{Cu}_{0.3}$ it is clear that they correspond to two different structures, being stable at different temperature ranges and with a small coexistence range (from 21 to 30K). These ($\text{TbPt}_{1-x}\text{Cu}_x$) samples were annealed after being crushed into fine powder in order to release the stress before the neutron experiments. For Ce and Nd the preparation procedure used in Tb compounds was not useful in these cases due to the very high degree of oxidation, however, the crystallographic structure was perfectly determined by X-ray and neutron diffraction and the homogeneity of the samples by scanning electron microscopy analysis. The coexistence of two propagation vectors remains at very low temperatures and, the structures are interpreted as a unique complex magnetic structure with two propagation vectors.

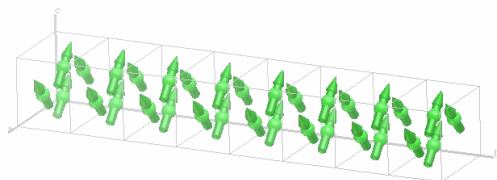

Figure 10a. Magnetic structure of $\text{TbPt}_{1-x}\text{Cu}_x$ with $x < 0.3$ of type $-\text{CxFz}$.

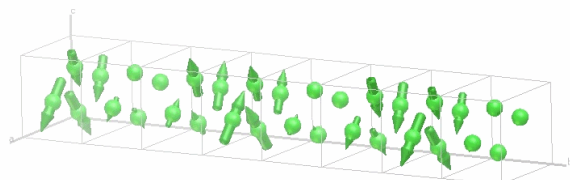

Figure 10b. Incommensurate magnetic structure of the annealed $\text{TbPt}_{0.7}\text{Cu}_{0.3}$ compound at 33 K.

The $\text{TbPt}_{0.7}\text{Cu}_{0.3}$ is an interesting case because the change from ferro to antiferromagnetism is studied as a function of temperature in the same compound. It is the paradigmatic border compound. The incommensurate sine modulated structure appearing just below T_N evolves to a pure non-collinear ferromagnetic one at very low temperatures. In figure 10 we present a picture of both type of structures. However, for the $\text{TbNi}_{0.6}\text{Cu}_{0.4}$ antiferromagnetic compound in the $\text{TbNi}_{1-x}\text{Cu}_x$ series, the incommensurate sine modulated structure is stable down to 1.3K. This fact was interpreted as a consequence of the “non Kramers” character of the Tb ion. In a low symmetry site, the crystalline electric field favours a singlet ground state and the magnetic moment at 0K depends on the ratio between the energy of the field acting on the ion (molecular field) and the energy gap between the two low lying singlet states. In this case, the modulated structure could be stable down to very low temperatures without increasing the system entropy [10]. For the corresponding $\text{TbPt}_{0.6}\text{Cu}_{0.4}$ compound, the antiferromagnetic structure with two propagation vectors is stable at least down to 1.5K, in agreement to the previous discussion. Then, the existence of a ferromagnetic structure at low temperatures for $\text{TbPt}_{0.7}\text{Cu}_{0.3}$ could be considered as a striking phenomenon. However, in this structure it was found experimental evidences owed to some reminiscence of the high temperature incommensurate structure. The relative strength of the positive and negative interactions is very critical and we can assert that for this compound the modifications imposed by temperature, both in the crystalline electric field scheme and in the conduction band, are enough to prevent the stability of the antiferromagnetic structure down to low temperatures.

In Gd compounds, we have not the structure for the border compound ($\text{GdNi}_{0.65}\text{Cu}_{0.35}$) but the effects of the absence of magnetocrystalline anisotropy are clear. The antiferromagnetic structures are helimagnetic. The magnetic moments lie in the ac plane and rotate along the b direction. This is an equal moment magnetic

structure, according with the Kramers character of the Gd ion.

The light Rare-Earths Nd and Ce series present the same kind of structures in the border compounds. $\text{NdNi}_{0.2}\text{Cu}_{0.8}$ and $\text{CeNi}_{0.2}\text{Cu}_{0.8}$ present both two propagation vectors at low temperatures, one corresponding to the ferromagnetic structure and a low angle peak, characteristic of an incommensurate one. The proposed structures are conical, but the absence of other magnetic peaks prevents further quantitative analysis. Both Ce and Nd are Kramers ions and then, equal moment structures are expected at low temperatures. However, some differences between the two structures can be detected. The larger width of the low angle peak in Ce indicates the existence of inhomogeneities in this incommensurate phase. In fact, this reflects the cluster-glass phase appearing at temperatures above the long-range ferromagnetic order in $\text{CeNi}_{1-x}\text{Cu}_x$ [15,19,23,24]. It is not surprising that magnetic inhomogeneities were also present in the incommensurate phases. This cluster-glass phase was not detected at all in the Nd compounds and, then, it was pointed out that the Kondo effect, reducing the value of the magnetic moments, play a crucial role in the stabilization of the cluster-glass and the percolative processes found in $\text{CeNi}_{1-x}\text{Cu}_x$ as an example characteristic of substitutional strongly correlated electron systems.

From the present analysis, we can ascertain that the process leading to the change from ferro to antiferromagnetism in intermetallic compounds is due to a concurrence of different phenomena: competing interactions, anisotropies, magnetic inhomogeneities and modifications of the conduction band. Complex magnetic structures always appear in the border compounds, always trying to transform the ferromagnetic commensurate structures into incommensurate ones and changing the magnetic moment direction. The modification of the conduction band, by modifications in the density of states at the Fermi level, seems to be the key parameter for this change. Antiferromagnetism favours three component moments.

In the case of supplementary magnetic inhomogeneities, as is the case of Kondo effect, the effect of disorder may even give rise to a clusterization phenomenon, which is even reflected in the conical structure of the Ce-based border compound. This study gives more insight to the importance of disorder in many magnetic phenomena, as the stability of very complex magnetic structures or the role of magnetic inhomogeneities in some physical properties, but also in the formation of new magnetic phases and percolative processes, which are often found when we discuss the properties of strongly correlated electron metals. [25, 26].

Acknowledgements

The neutron experiments were performed at the Laboratoire Leon Brillouin (Saclay, France) and at the Institute Lane-Langevin (Grenoble, France), we acknowledge their technical and scientific teams for their

assistance and help to perform the experiments. This work is supported by the Spanish CICYT grant

MAT2005-06806-C04-02 and the ECOM COST Action P16

References

1. *Handbook on the Physics and Chemistry of Rare Earths*. Karl Gschneidner Jr. Jean-Claude Bunzli and Vitalij Pecharsky. Elsevier-North-Holland, **38** (2008).
2. E O Wollan and C G Shull *Phys. Rev.* **73** (1948) 830.
3. *Theory of Magnetic Neutron and Photon Scattering* Ewald Balcar and Stephen W Lovesey. Published by Oxford University Press, (1989). *Magnetism in Metals: A Symposium in Memory of Allan MacKintosh*. D. F. McMorrow, Jens Jensen, Allan R Mackintosh, H M Rønnow. Published by Kgl Danske Videnskabernes Selskab (1997).
4. A Szytula, *Handbook of Magnetic Materials*, edited by K H J Buschow, Elsevier, New York, **6** Chap. 2, (1991) 85.
5. Yu A Izyumov, V E Naish, and R P Ozerov, *Neutron Diffraction of Magnetic Materials*, Consultants Bureau, New York, (1991); J Rodríguez-Carvajal, *Physica B* **192** (1993) 55.
6. E Miranda and V Dobrosavljevic, *Rep. Prog. Phys.* **68** (2005) 2337.
7. G R Stewart, *Rev. Mod. Phys.* **73** (2001) 797.
8. E Dagotto, in *Nanoscale Phase Separation and Colossal Magnetoresistance*, Springer-Verlag, Berlin, (2002).
9. See for instance *Handbook on the Physics and Chemistry of Rare Earths*. **14** (1991), **30** (2000), **32** (2002), **33** (2003), **34** (2004).
10. D Gignoux and J C Gómez Sal, *J. Magn. Magn. Mater.* **1** (1976) 203. J C Gómez Sal, J I Espeso, J Rodríguez Fernández, N Marcano and J A Blanco, *J. Magn. Magn. Mater.* **242-245** (2002) 125.
11. A Señas, J Rodríguez Fernández, J C Gómez Sal, J Campo and J Rodríguez-Carvajal, *Phys. Rev. B* **70** (2004) 184425.
12. J A Blanco, J C Gómez Sal, J Rodríguez Fernández, D Gignoux, D Schmitt and J Rodríguez-Carvajal, *J. Phys.: Cond. Matt.* **4** (1992) 8233.
13. J García Soldevilla, J A Blanco, J Rodríguez Fernández, J I Espeso, J C Gómez Sal, M T Fernández-Díaz, J Rodríguez-Carvajal and D Paccard, *Phys. Rev. B* **70** (2004) 224411.
14. J I Espeso, J García Soldevilla, J A Blanco, J Rodríguez Fernández, J C Gómez Sal and M T Fernández-Díaz, *Eur. Phys. J. B* **18** (2000) 625.
15. N Marcano, J C Gómez Sal, J I. Espeso, J M de Teresa, P A Algarabel, C Paulsen and J R Iglesias, *Phys. Rev. Lett.* **98** (2007) 166406.
16. A Hernando, J M Rojo, J C Gómez Sal and J M Novo, *J. Appl. Phys.* **79** (1996) 4815.
17. D Gignoux and J C Gómez Sal, *Phys. Rev. B* **30** (1986) 3967. J C Gómez Sal, J I Espeso, J Rodríguez Fernández, J A Blanco and J Rodríguez-Carvajal, *Solid State Commun.* **87** (1993) 863. J A Blanco, M de Podesta, J I Espeso, J C Gómez Sal, C Lester, K A McEwen, N Patrikios and J Rodríguez Fernández, *Phys. Rev. B* **49** (1994) 15126.
18. N Marcano, J I Espeso, J C Gómez Sal, J Rodríguez Fernández, J Herrero-Albillos and F Bartolomé, *Phys. Rev. B* **71** (2005) 134401.
19. N Marcano, J C Gómez Sal, J I Espeso, L Fernández Barquín and C Paulsen, *Phys. Rev. B* **76** (2007) 224419.
20. E F Bertaut, *Acta Crystallogr., Sect. A: Cryst. Phys., Diffraction, Theor. Gen. Crystallogr.* **24** (1968) 217.
21. D Gignoux, PhD. Thesis at the University of Grenoble (1973).
22. J A Blanco, J C Gómez Sal, J. Rodríguez Fernández, M Castro, R Burriel, D Gignoux and D Schmitt. *Solid St. Communications.* **89** (1994) 389-392.
23. A H Castro Neto, G Castilla and B A Jones, *Phys. Rev. Lett.* **81** (1998) 3531. R B Griffiths, *Phys. Rev. Lett.* **23** (1969) 17.
24. J A Mydosh, *Spin Glasses: An Experimental Introduction* Taylor & Francis, London, (1993).
25. A H Castro Neto, G Castilla and B A Jones, *Phys. Rev. Lett.* **81** (1998) 3531.
26. A Schröder, G Aeppli, R Coldea, M Adams, O Stockert, H von Löhneysen, E Bucher, R Ramazashvili, and P Coleman, *Nature* (London) **407** (2000) 351; B L Young, D E MacLaughlin, M S Rose, K Ishida, O O Bernal, H G Lukefahr, K Heuser, G R Stewart, N P Butch, P C Ho and M B Maple, *Phys. Rev. B* **70** (2004) 024401. E D Bauer, V S Zapf, P C Ho, N P Butch, E J Freeman, C Sirvent and M B Maple, *Phys. Rev. Lett.* **94** (2005) 046401.